



Sivoia QED™

quiet electronic drive systems

roller shades
Roman shades
drapery tracks

natural light control

redefined by the world's
leading manufacturer of
lighting control systems



 **LUTRON**
Lutron controls your light.™

Sivoia QED™ | quiet electronic drive systems

Quality and Performance

The Sivoia QED family of shading and drapery systems offer touch-of-a-button convenience and provide:

- near-silent performance
- smooth operation and perfect alignment across multiple shades
- glare reduction to enhance productivity
- protection of furnishings from UV damage
- easy installation in new or existing spaces
- seamless communication with Lutron lighting control systems

Engineered by Lutron for elegant, precise performance

- low-voltage electronic drive unit concealed within roller tube
- built-in intelligence allows for flexible control of groups of shades without dedicated line-voltage wiring or external group controllers
- elegant keypads with electronic preset capabilities to program shade positions



Typical components for a Sivoia QED roller shade system (not shown to scale)

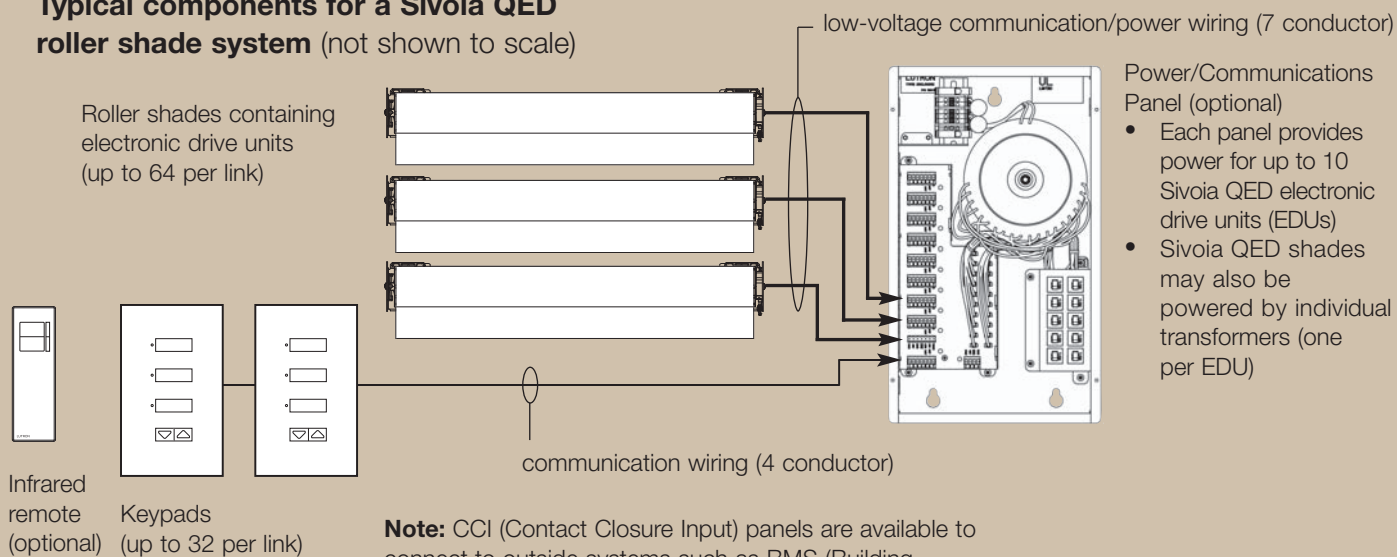

Note: CCI (Contact Closure Input) panels are available to connect to outside systems such as BMS (Building Management Systems) or touchscreen systems.

Sivoia QED™ | system options and dimensions

Roller 100™ | system dimensions

The Roller 100 system utilizes a 2.5" diameter roller tube to operate up to 100 square feet of fabric. Light gaps are symmetrical.

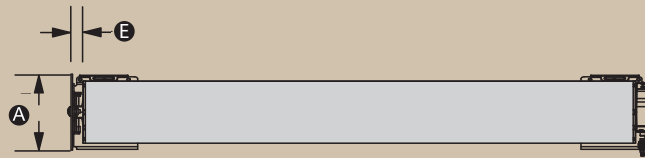

Front view

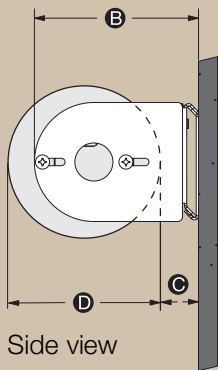

Side view

- A. 4.00" (10.6cm)
- B. 4.30" (10.92cm)
- C. 1.00" (2.54cm)
- D. 5.00" (12.70cm)
- E. 0.625" (15.8 mm) minimum, 0.75" (19.1 cm) typical

Roller 225™ | system dimensions

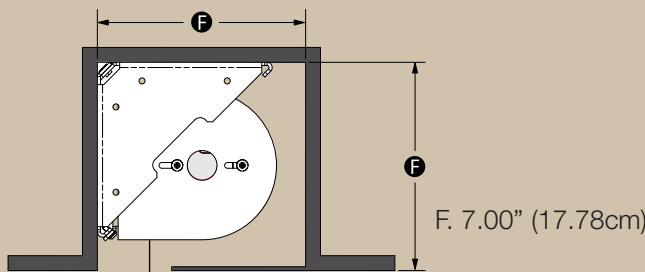

Side view

F. 7.00" (17.78cm)

The Roller 225 system utilizes a 3.75" diameter roller tube, allowing the Sivoia QED system to operate up to 225 square feet of fabric. Light gaps are symmetrical.

Installation Options

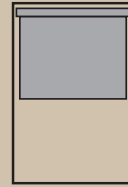

Inside Mount

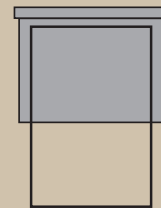

Outside Mount

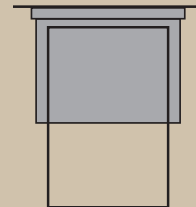

Ceiling Mount

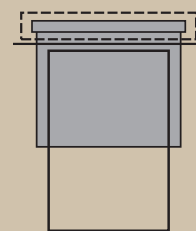

Pocket Mount



Lutron | total light control

Make a space as productive as possible with one-touch control of both electric and natural light. Maximize energy efficiency and comfort throughout an entire building with automated adjustment of shades and lighting, all from a single system.

Roman Shades and Drapery Track

For information on Sivoia QED Roman Shade and Drapery Track Systems, please visit www.lutron.com.

Sivoia QED™ | specification overview

About Lutron

Lutron has been the world's leading manufacturer of lighting control systems for over 40 years, continually innovating, while offering world-class service and support.

Ultra-Quiet Electronic Drive

The Sivoia QED system is low-voltage and operates at a near-silent level (rated at 44 dBA at three feet). Shades move smoothly and stop at preset positions with no audible clicks.

Speed Control

All shades in a Sivoia QED system will track together and stop at programmable preset positions to within 1/8 inch. By utilizing a unique **intelligent hembar alignment™** enhancement, Roller 100 and Roller 225 shade systems will move and track together, even though they use different size roller tubes.

Minimal, Symmetrical Light Gaps

Sivoia QED roller shade systems offer typical light gaps of 3/4 inch per side.

Simple Reconfiguration

The Sivoia QED system can easily be reconfigured, limits can be changed, and presets can be reprogrammed without rewiring and without access to the electronic drive unit (EDU).

Limits and Presets Never Lost

Limits and preset shade positions are electronically precision-set and locked into a 10-year power-failure memory. These limits and presets will never slip regardless of age, electrostatic discharge, or power failure.

Simplified Wiring

Sivoia QED shading systems do not require any group controllers, relays, or line-voltage wiring between electronic drive units. Wiring can be simplified by using an optional Sivoia QED power panel, allowing all system wiring to be run to one convenient location.

Elegant Control Options

Lutron controls are designed to match the high-end look and feel of today's premiere working and living spaces and are available in a wide variety of colors and finishes, including metals.

Wide Array of Fabrics

Lutron shading systems are available in fabric styles to suit any function or aesthetic need, including many PVC-free fabric choices.

System Integration

Lutron lighting control systems, such as RadioTouch™, GRAFIK Eye™, and HomeWorks® seamlessly integrate with Sivoia QED shades, offering intuitive control of both lighting and shades.



Sustainable Design and LEED™

Lutron offers integrated control solutions and project management support to complement your design goals, providing contributions toward 5 of 6 LEED credit categories.

System Warranty and Support

Sivoia QED systems come with an 8-year limited warranty, plus optional extended service. Lutron has factory-employed field service engineers throughout the world and is the only lighting control or shade systems manufacturer in the world with a 24-hour / 7 days a week technical support center. For more details, including CSI formatted specs, visit www.lutron.com/shadingsolutions

©2005 Lutron Electronics Co., Inc.
P/N 367-946 01/05
www.lutron.com